

****Drawing Not to Scale****

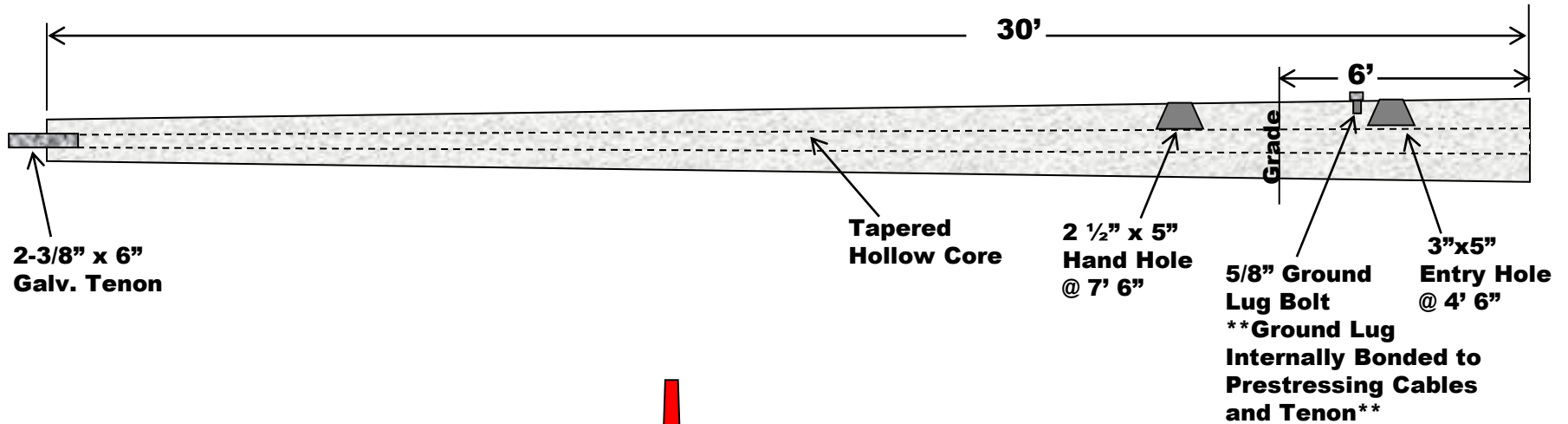

Seminole Pole

incorporated

www.SeminolePole.com
Phone: 866-246-5545

Email: SeminolePole@gmail.com
Fax: 229-524-2866

Part#: SP3024TII

Project:

Pole O.A.	Burial Depth	Wind Speed	Gust	EPA Capacity
30'	6'	140mph	3 sec.	7.0
Min. Brk. Strength	Strand Info	Concrete	Pole Weight (lb)	
3,500#	0.5" Diameter 270 ksi	6,500psi	1,680	

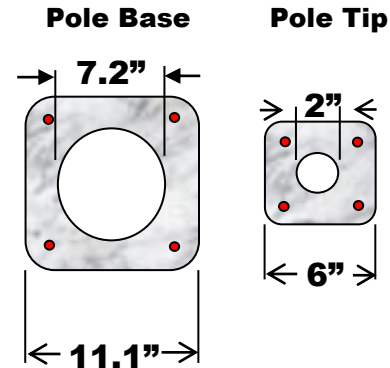

● =0.5" Diameter 7 Wire
270k Low Relaxation
Cable

